

Part A (Attempt any 15 ONLY)

1. A rectangular photo frame of size 30 cm × 40 cm has a photograph mounted at the centre leaving a 5 cm border all around. The area of the border is?

- (1) 600 cm² (2) 350 cm²
(3) 400 cm² (4) 700 cm²

2. At a birthday party, every child gets 2 chocolates, every mother gets 1 chocolate, while no father gets a chocolate. In total 69 persons get 70 chocolates. If the number of children is half of the number of mothers and fathers put together, then how many fathers are there?

- (1) 22 (2) 23
(3) 24 (4) 69

3. What is the value of:

$$1^2 - 2^2 + 3^2 - 4^2 + 5^2 - \dots + 17^2 - 18^2 + 19^2?$$

- (1) -5 (2) 12
(3) 95 (4) 190

4. The curves of $y = 2x^2$ and $y = 4x$ intersect each other at:

- (1) only one point. (2) exactly two points.
(3) more than two points (4) no point at all.

5. The diameters of the pinholes of two otherwise identical cameras A and B are 500 μm and 200 μm, respectively. Then the image in camera A will be

- (1) sharper than in B
(2) darker than in B
(3) less sharp and brighter than in B
(4) sharper and brighter than in B

6. If $D = ABC + BCA + CAB$

where A, B and C are decimal digits, then D is divisible by

- (1) 37 and 29 (2) 37 but not 29
(3) 29 but not 37 (4) Neither 29 nor 37

7. For the following set of observed values:

{60, 65, 65, 70, 70, 70, 70, 82, 85, 90, 95, 95, 100, 160, 160},

Which of the statements is true?

- (1) mode < median < mean
(2) mode < mean < median
(3) mean < median < mode
(4) median < mode < mean

8. A circular running track has six lanes, each 1 m wide. How far ahead (in metres) should the runner in

the outermost lane start from, so as to cover the same distance in one lap as the runner in the innermost lane?

- (1) 6π (2) 10π
(3) 12π (4) 36π

9. In an examination 100 questions of 1 mark each are given. After the examination, 20 questions are deleted from evaluation, leaving 80 questions with a total of 100 marks. Student A had answered 4 of the deleted questions correctly and got 40 marks, whereas student B had answered 10 of the deleted questions correctly and got 35 marks. In this situation

- (1) A and B were equally benefitted.
(2) A and B lost equally.
(3) B lost more than A.
(4) A lost more than B.

10. A tourist drives 20 km towards east, turns right and drives 6 km, then drives 6 km towards west. He then turns to his left and drives 4 km and finally turns right and drives 14 km. Where is he from his starting point?

- (1) 6 km towards east (2) 20 km towards west
(3) 14 km towards north (4) 10 km towards south

11. If 'SELDOON' means 'NOODLES' then what does 'SPUOS' mean?

- (1) SALAD (2) SOUPS
(3) RASAM (4) ONION

12. An ideal pendulum oscillates with angular amplitude of 30° from the vertical. If it is observed at a random instant of time, its angular deviation from the vertical is most likely to be

- (1) 00 (2) ±100
(3) ± 200 (4) ± 300

13. In the context of tiling a plane surface, which of the following polygons is the odd one out?

- (1) Equilateral triangle (2) Square
(3) Regular pentagon (4) Regular hexagon

14. Scatter plots for pairs of observations on the variables x and y in samples A and B are shown in the figure.

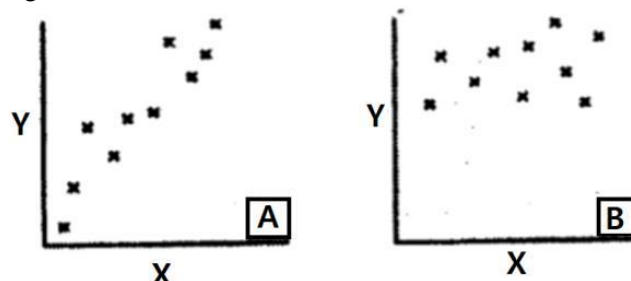

Which of the following is suggested by the plots?

(3) Alanine is a major precursor for the biosynthesis of porphyrin.

(4) Tryptophan is converted to L-DOPA in the biosynthesis of epinephrine.

24. Which one of the following statements on nucleic acids is NOT true?

(1) The conformation of ribose in DNA is α - 2'-deoxy-D-ribofuranose.

(2) Hydrolysis of RNA takes place under alkaline conditions unlike DNA, as the 2'-hydroxyl in RNA acts as a nucleophile in an intramolecular displacement

(3) DNA can occur in different three- dimensional forms.

(4) In DNA, deamination of cytosine to uracil can occur in a non-enzymatic manner.

25. If one of the two fatty acyl chains is removed from- the phosphoglyceride by hydrolysis in solution, such phospholipids will form:

(1) liposomes

(2) micelles

(3) phospholipid bilayer

(4) symmetric phospholipid bilayer

26. In metazoan cell cycle, metaphase to anaphase transition is regulated by the activity of:

(1) Cdk1/cyclinB (2) APC/C

(3) Cdc25 (4) Wee1

27. Which one of the following statements is true about human chromosomes?

(1) The chromosomes that have highest gene density generally localize towards the centre of the nucleus.

(2) The chromosomes that have highest gene- density generally localize near the nuclear periphery to facilitate rapid transport of the nascent transcripts.

(3) The centromeres of different chromosomes tend to cluster together at the centre of the nucleus.

(4) Chromosomal positioning in the nucleus is absolutely random.

28. Which one of the following activities is NOT involved in protein folding in the endoplasmic reticulum?

(1) Peptidyl prolyl isomerase

(2) Protein disulphide isomerase

(3) Protein glycosylation

(4) Protein ubiquitination

29. Which one of the following statements is NOT correct?

(1) Together with proteins, rRNA provides a site for polypeptide synthesis.

(2) All DNA molecules are unbranched polymers of nucleotides.

(3) DNA is synthesized in a 5'- 3' direction while RNA synthesis occurs in a 3'- 5' direction.

(4) A tRNA anticodon may pair with more than one codon.

30. What would be the tripeptide produced by translation of the transcript produced by the following DNA sequence?

3'-AAGTA CTCT-5'

(1) Arg- Phe- Trp (2) Arg - Leu - Gly

(3) Thr- Lys – Ser (4) Phe - Met – Arg

31. Which one of the following statements is generally true about RNA polymerase II?

(1) It is dedicated to transcribing RNA from a single transcription unit, generally a large transcript- which is then processed to yield three types of ribosomal RNA.

(2) It transcribes varieties of small non- coding RNAs which are expressed in all cell types.

(3) It generally synthesizes various types of mRNAs and small non-coding RNAs.

(4) It is exclusively involved in synthesis of rRNA and tRNA.

32. Viruses adopt different strategies to suppress immune response of the host. Which one of the following statements is NOT correct?

(1) Human Immunodeficiency Virus (HIV) destroys CD4+T cells.

(2) Epstein-Barr Virus (EBV) produces a homolog of human IL- 10.

(3) Human influenza virus directly infects CD8+ T cells.

(4) Human Cytomegalo Virus (CMV) establishes latent- infection in bone marrow stem cells.

33. Which one of the following inactivates the serine/threonine protein kinase, mTOR, related to cell growth in mammalian system?

(1) Rifamycin (2) Rapamycin

(3) Erythromycin (4) Chloramphenicol

34. Match the following tumor cell origin with their nomenclature.

Tumor cell origin		Nomenclature	
A	Muscle cell	a	Carcinoma

B	Germ cell	b	Sarcoma
C	Epithelial cell	c	Lukemia
D	White blood cell	d	Teratocarcinoma

- (1) A - a, B - c, C - d, D - b
 (2) A - d, B - a, C - b, D - c
 (3) A - c, B - b, C - d, D - a
 (4) A - b, B - d, C - a, D - c

35. Many cytotoxic T lymphocytes initiate killing of target cells via delivery of molecules that could induce target-cell damage directly. Which one of the following is the most appropriate?

- (1) Interferon γ (2) Peroxynitrite
 (3) Lysozyme (4) Granzyme

36. Membrane-bound, Golgi-derived structures containing proteolytic enzymes in sperms of sea urchin are called

- (1) cortical granules (2) micromeres
 (3) acrosomal vesicles (4) macromeres

37. In case of Hydra, the major head inducer of the hypostome organizer is a set of Wnt proteins acting through the canonical β -catenin pathway. What would be the result, if a transgenic Hydra is made to globally mis-express the downstream Wnt effector β -catenin?

- (1) Ectopic buds will be formed all along the body axis and even on the top of the newly formed buds.
 (2) Ectopic tentacles form at all levels.
 (3) Both ectopic tentacles and buds would be formed along the body axis.
 (4) There would be no change observe

38. Both TGF β and Sonic hedgehog signals play important roles in both neurulation and cell-fate patterning of the neural tube. Which one of the following statements is true?

- (1) High levels of BMP specify the cells to become epidermis.
 (2) Very low levels of BMP specify the cells to become epidermis.
 (3) High levels of BMP specify the cells to become neural plate.
 (4) Intermediate levels of BMP do not effect the formation of neural crest cells.

39. In which stage of *Arabidopsis* embryogenesis is hypophysis first observed?

- (1) Octant (2) Dermatogen
 (3) Globular (4) Transition

40. Which one of the following mineral deficiency will first be visible in younger leaves?

- (1) Calcium (2) Nitrogen
 (3) Zinc (4) Molybdenum

41. The CO₂ compensation point for C₃ plants is greater than C₄ plants because in C₃ plants

- (1) dark respiration is higher
 (2) dark respiration is lower
 (3) photorespiration is present
 (4) photorespiration is absent

42. Which one of the following best describes the function of Casparian bands during the translocation of nutrients and water across the root?

- (1) Block apoplastic nutrient transport
 (2) Block symplastic nutrient transport
 (3) Act as a nutrient carrier
 (4) Help in creating passage cells

43. Which one of the following components is expected to be most abundant in the phloem sap of a plant?

- (1) Proteins (2) Organic acids
 (3) Sugars (4) Phosphates

44. Which one of the following is NOT secreted by capillary endothelium?

- (1) Prostacyclin (2) Guanosine
 (3) Endothelin (4) Nitric oxide

45. The "Mayer waves" in the blood pressure originate due to

- (1) systole and diastole of ventricle
 (2) inspiration and expiration
 (3) reflex oscillation of neural pressure control mechanisms
 (4) Bainbridge reflex

46. The maturation of red blood cells does not depend on

- (1) folic acid (2) vitamin B12
 (3) pyridoxine (4) tocopherol

47. Which one of the following is NOT a function of angiotensin II?

- (1) Facilitates the release of norepinephrine from post-ganglionic sympathetic neurons
 (2) Increases the sensitivity of baroreflex by acting on brain
 (3) Produces arteriolar contraction
 (4) Increases the secretion of vasopressin

48. The pedigree below represents the inheritance of an autosomal recessive trait.

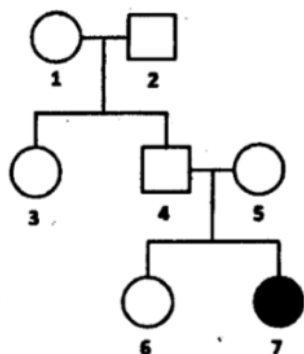

What is the probability that individual '6' is a heterozygote?

- (1) 1/4 (2) 1/2
(3) 2/3 (4) 1/3

49. The allele *l* in *Drosophila* is recessive, sex-linked and lethal when homozygous or hemizygous. If a female of the genotype *Ll* is crossed with a male, what is the ratio of females : males in the progeny?

- (1) 3 female: 1 male (2) 2 female: 1 male
(3) 1 female: 1 male (4) 1 female: 2 male

50. Deamination of bases is a common chemical event that produces spontaneous mutation. Which one of the following bases will be formed by deamination of 5-methylcytosine?

- (1) Uracil (2) Thymine
(3) Cytosine (4) Guanine

51. In a population of 2000 individuals of a plant species, genetic difference at a single locus leads to different flower colours. The alleles are incompletely dominant. The population has 100 individuals with the genotype *rr* (white flowers), 800 individuals with the genotype *Rr* (pink flower) and the remaining have genotype *RR* (red flowers). What is the frequency of the *r* allele in the population?

- (1) 0.25 (2) 0.50
(3) 0.75 (4) 1.00

52. Which of the following plastid coding region(s) have been recommended as a core barcode by Plant Working Group of the consortium for the Barcode of Life?

- (1) CO1 and *rbcL* (2) *rbcL* and *matK*
(3) CO1 and *matK* (4) *rbcL* only

53. Given below are some statements related to lower eumetazoans. Select the INCORRECT statement.

- (1) Ctenophores are diploblastic with radial symmetry.
(2) Placozoans, with weakly differentiated tissue layers, are not diploblasts.
(3) Cnidarians are diploblastic with typically two stages in their life cycle
(4) Hydrozoans, a Cnidarian class, often have colonial polyps in their life cycle.

54. Based on the type of excretion of nitrogenous waste, animals can be categorized as ammonotelic, ureotelic and uricotelic. Given below are combinations of groups of organisms and type of excretion. Select the correct combination.

- (1) Poriferans, adult amphibians, cartilaginous fishes are ammonotelic.
(2) *Ascaris*, cockroaches, prawn are uricotelic.
(3) *Paramecium*, amphibian tadpoles, crocodiles are mainly ammonotelic.
(4) Humans, sharks and aquatic anurans are ureotelic.

55. Basal angiosperms are NOT represented by the members of:

- (1) Chloranthales (2) Nymphaeales
(3) Austrobaileyales (4) Amborellales

56. Which of the following is the correct increasing order for the daily net primary productivity (NPP) per unit leaf area in different ecosystems?

- (1) Deserts < Temperate forests < Tropical forests
(2) Deserts < Tropical forests < Temperate forests
(3) Temperate forests < Tropical forests < Deserts
(4) Tropical forests < Temperate forests < Deserts

57. The equilibrium model of island biogeography proposed by MacArthur and Wilson assumes that the number of species on an island represents a balance between

- (1) resource consumption rate and predation rate.
(2) birth rate and death rate.
(3) colonization rate and extinction rate.
(4) speciation rate and hybridization rate

58. A population grows according to the logistic growth equation,

$$\frac{dN}{dT} = rN \left(1 - \frac{N}{K}\right)$$

Where, dN/dT is the rate of population growth, r is the intrinsic rate of increase, N is population size and K is the carrying capacity of the environment. According to this equation, population growth rate is maximum at

- (1) $K/4$ (2) $K/2$

(3) K (4) 2K

59. What is the significance of upwelling zone for marine ecosystems?

- (1) It is responsible for uniformity of temperature in ocean to support the marine life.
- (2) It brings nutrients from deeper zones to relatively nutrient poor ocean surface thus increasing marine productivity.
- (3) It is responsible for uniform oxygenation of marine waters thus increasing marine productivity.
- (4) It helps in circulating decomposers from the bottom of ocean to surface for proper decomposition of dead material on the surface.

60. Given below in Column A are schematic representations of three types of pairwise species interactions and the name of some interactions are in Column B.

Column A	Column B
	(i) Apparent competition
<p style="text-align: center;">Shared Resource</p>	(ii) Interference competition
<p style="text-align: center;">Herbivore</p>	(iii) Direct amensalism
	(iv) Exploitation competition

Select the best match for interaction between column A & B in each schematic.

- (1) A - (iii); B - (ii); C - (iv)
- (2) A - (iv); B - (ii); C - (iii)
- (3) A - (ii); B - (iv); C - (i)
- (4) A - (iii); B - (i); C - (ii)

61. Consider a single locus with 2 alleles which are at Hardy-Weinberg equilibrium. If the frequency of one of the homozygous genotypes is 0.64, what is the frequency of heterozygotes in the population?

- (1) 0.16 (2) 0.20
- (3) 0.32 (4) 0.36

62. Competition for mates and variance in fitness is higher among females than among males in which of the following animal mating systems ?

- (1) Monogamy (2) Polygyny
- (3) Polyandry (4) Sequential monogamy

63. Which one of the following will have the least impact on allele frequencies in small populations?

- (1) Inbreeding (2) Random mating
- (3) Genetic drift (4) Outbreeding

64. Given below is a marker profile for two parental lines (P1 and P2) and their derived F1 progeny:

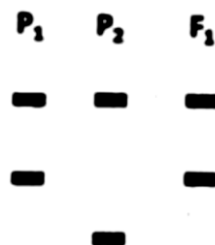

The marker that is represented in the above figure is most likely to be

- (1) RFLP or SSR (2) SSR only
- (3) SSR or RAPD (4) RAPD only

65. DNA vaccines offer several advantages over other existing vaccine approaches. Which one of the following statements related to DNA vaccine is NOT correct?

- (1) The immune response is directed to the antigen encoded by the DNA and able to induce both humoral and cell-mediated immunity.
- (2) DNA vaccine can induce prolonged expression of the antigen, enhancing the induction of immunological memory
- (3) DNA vaccine could remain stable and potent for long time without refrigeration, eliminating the challenges of storage and transportation.
- (4) DNA vaccine construct can be engineered to carry several antigens to infect host and replicate in neuronal cells.

66. The following cassette was designed to create estrogen receptor knock-out mice:

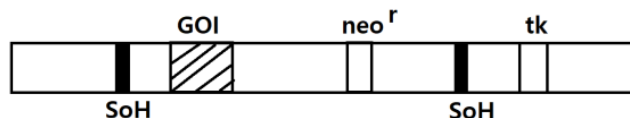

SoH: site of homology; GOI: gene of interest
What would ensure that proper recombination has taken place?

- (1) Cells survive when cultured in presence of only G418
- (2) Cells survive when cultured in presence of G418 followed by ganciclovir
- (3) Cells die when cultured in presence of G418

(4) Cells survive when cultured with G418 and die when cultured with ganciclovir

- (1) B, D (2) A, C
(3) A, D (4) C, D

67. Detergents at low concentration generally do not denature proteins and are thus used for extracting proteins in their folded and active form. For isolation of Porins, an *E. coli* membrane protein, which one of the following purification approaches will be most appropriate?

- (1) Use of low concentration of non-ionic detergent without salt.
(2) Use of low concentration of ionic detergent.
(3) Use of salt solution containing non- ionic detergent.
(4) Use of salt solution containing ionic detergent.

68. Choose the correct answer from the statements indicated below:

- (1) Chi square test is parametric.
(2) Non-parametric test assumes normal distribution.
(3) Results can be significantly affected by outliers in a parametric test.
(4) Non-parametric test is more powerful as compared to parametric test.

69. Which one of the following statements regarding restriction/modifying enzymes used in recombinant DNA technology is correct?

- (1) Endonucleases remove nucleotides, one at a time, from the ends of a sequence.
(2) Type II class of restriction enzymes do not recognise palindromic sequences.
(3) Mung bean nuclease acts on double stranded DNA or RNA termini.
(4) Type II class of restriction enzymes can generate either "sticky" (staggered) or "blunt" ends

70. Which one of the following is used as a source of excitation in a confocal microscope?

- (1) Lasers (2) Electron beam
(3) Mercury lamp (4) Masers

Part C (Attempt any 25 ONLY)

71. Following are statements on β -turns:

- A. All the 20 coded amino acids have equal propensity to form β -turns.
B. Pro cannot occur in β -turns.
C. Pro-Gly sequence strongly favours β -turns.
D. In Asn-Gly β -turns, Asn can have positive ϕ , Ψ values.

Choose the combination with all correct statements

72. DNA melting temperature (T_m) was found to be 47°C and enthalpy measured at T_m was 0.032 kJ. The entropy change would be:

- (1) 1×10^{-3} kJ (2) 1×10^{-4} kJ
(3) 3×10^{-2} kJ (4) 6×10^{-2} kJ

73. Match the following bonds with their approximate energies:

(a)	Hydrogen bond	(i)	0.5 Kcal
(b)	Van der walls forces	(ii)	40 Kcal
(c)	Covalent bond	(iii)	80 Kcal
(d)	Ionic bond	(iv)	3 Kcal

- (1) (a)-(iv), (b)-(iii), (c)-(ii), (d)-(i)
(2) (a)-(ii), (b)-(i), (c)-(iii), (d)-(iv)
(3) (a)-(i), (b)-(iv), (c)-(ii), (d)-(iii)
(4) (a)-(iv), (b)-(i), (c)-(iii), (d)-(ii)

74. The following are some statements regarding glycolysis:

- A. Glycolysis is not regulated by pyruvate kinase.
B. Lactate can be an end product of glycolysis.
C. Glycolysis cannot function anaerobically.
D. In erythrocytes, the second site in glycolysis for ATP generation can be bypassed.

From the above, choose the combination with both INCORRECT statements:

- (1) A and B (2) B and D
(3) C and D (4) A and C

75. For a reversible non-competitive inhibition of an enzyme, choose the plot that you would use to determine K_m :

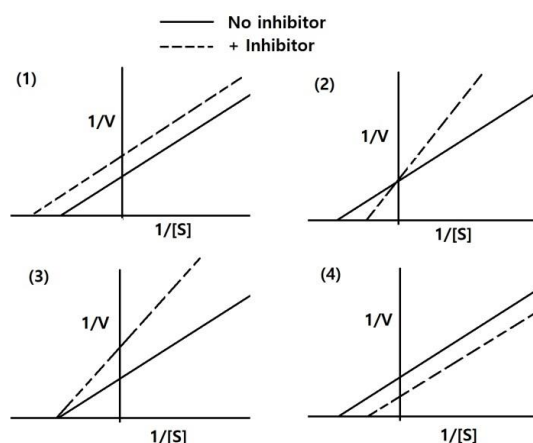

- (1) Fig.1 (2) Fig.2
(3) Fig.3 (4) Fig.4

76. An investigator expresses a GFP-fused protein that localizes to the outer membrane of Golgi apparatus. Upon visualising GFP signal in the fluorescence microscope, it was noted that GFP is pericentrosomal in its localization (Fig A). Treatment of such GFP expressing cells with a newly identified drug disrupted the Golgi into small vesicles (Fig B).

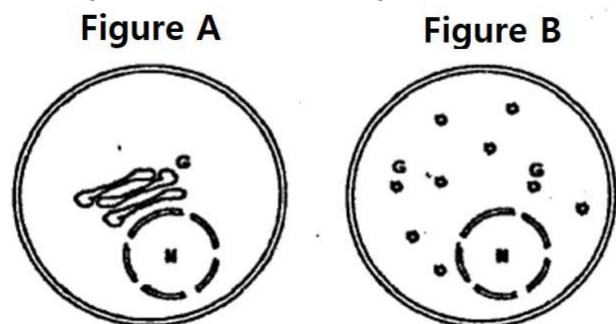

Following is a list of potential targets of the drug:

- A. Dynein complex
- B. Myosin
- C. Microtubules
- D. Dicer

Choose the combination with all correct targets:

- (1) A, B and D only
- (2) B and D only
- (3) A and C only
- (4) A only

77. Following observation was made when a mammalian cell in one phase of cell cycle was fused with a cell in another phase of cell cycle:

- A. Fusion of a cell in G1 phase with S phase caused the G1 nucleus to enter S phase.
- B. Upon fusion of a G2 cell with an S phase cell, G2 cell does not enter S phase.
- C. Upon fusion of a G1 cell with G2 cell, G1 nucleus enters G2 phase.
- D. Fusion of an S phase cell with a M phase causes the S phase cell to immediately enter mitosis.

Choose the combination with all correct statements.

- (1) A, B, C
- (2) A, C, D
- (3) B, C, D
- (4) A, B, D

78. In an experiment, intact chromatin was isolated and digested with micrococcal nuclease in independent tubes for 30 min, 1 h, 2h, and 4h. Further, the DNA was purified from each tube, separated on agarose gel and Southern hybridization was performed with rRNA gene probe and a centromeric DNA probe. Which one of the following patterns of signal intensity from both of the probes is likely to be obtained following Southern hybridization?

(1) With increasing time, compared to centromeric probe, a rapid increase in signal intensity of rRNA gene probe was observed.

(2) With increasing time, compared to centromeric probe, a rapid decrease in signal intensity of rRNA gene probe was observed.

(3) Irrespective of incubation period, both probes produced identical band intensities.

(4) Treatment with micrococcal nuclease would instantly degrade the DNA, hence, no hybridization signal would be obtained in any of the samples.

79. Which one of the following proteins is most likely to be found in the inter-membrane space of mitochondria? A protein containing

- (1) an N-terminal matrix targeting sequence followed by hydrophobic stop-transfer anchor sequence
- (2) an N-terminal matrix targeting sequence followed by a cleavable hydrophobic sequence that blocks complete translocation
- (3) a protein with multiple internal sequences that are recognized by Tim 22 complex
- (4) a protein with an outer membrane localization sequence followed by a matrix targeting signal

80. A single protofilament of microtubule grows at the speed of 2 $\mu\text{m}/\text{min}$. Considering that there is no catastrophe in the microtubule nucleation and the size of the tubulin unit is of the order of 5 nm, how many tubulin units are added to the growing microtubule per minute?

- (1) 400
- (2) 1600
- (3) 3200
- (4) 5200

81. mRNA of a gene was depleted in human cells using siRNA that arrest cells in the G2 phase of the cell cycle. In order to test whether the G2 arrest is due to an off-target or all on-target effect of siRNA mediated mRNA depletion, an investigator can:

- A. re-introduce an ectopic copy of the gene coding for the wild-type mRNA and protein
- B. re-introduce an ectopic copy of the gene that is different in its mRNA sequence at the siRNA target site but encodes for the same protein
- C. re-introduce an ectopic copy of the gene that codes for-different mRNA and protein
- D. utilize few more siRNAs targeting different regions of the mRNA in question

Choose the combination with correct statements:

- (1) A, B, C only
- (2) C and D only
- (3) B and D only
- (4) B, C, D only

82. Presence of selenocysteine in proteins in *E. coli* is a consequence of:

(1) post-translational modification of cysteine present in special structural regions of the proteins by SelB and SelC.

(2) post-translational modification of serine present in special structural regions of the proteins by SelB and SelC.

(3) aminoacylation of a special tRNA (tRNA^{SeCys}) by serine tRNA synthetase with serine followed by further modification of the attached serine to selenocysteine followed by its transport to the ribosome by SelB

(4) aminoacylation of a special tRNA (tRNA^{SeCyt}) by serine tRNA synthetase with selenocysteine followed by its transport to ribosome by SelB.

83. A DNA segment was cloned into the active site region of *lac Z* gene and the recombinant plasmid introduced into *lac Z*- strain of *E. coli* and plated on a medium containing X-gal. The colonies showed blue color. Which one of the following statements is correct? ·

(1) The nature of the cloned DNA segment need not be special as cloning of any DNA in *lac Z* will result in disruption of its reading frame and production of blue colour on X-gal plates.

(2) The cloned DNA segment could be a Group I intron whose removal from the precursor *lac Z* transcript in *E. coli* results in production of mature *lac Z* mRNA which can then produce active Lac Z protein.

(3) The cloned sequence is likely to be *lacY* sequence which is naturally a part of *lac* operon in *E. coli*.

(4) The cloned sequence is likely to be an anti-terminator sequence which allows full length transcription of *lac Z*.

84. An intron in a yeast reporter gene carries a mutation in the splice site branch point (UACUAAC to UACA*AAAC). To suppress the mutation, a library of point mutants of snRNAs was introduced into the mutant strain. The suppressor is most likely to have a point mutation in:

(1) U1 snRNA (2) U2 snRNA

(3) RNaseP (4) U6 snRNA

85. A researcher wanted to identify the enhancer-sequences of a newly discovered gene. Shown below are the relevant regions of some of the reporter constructs the researcher designed to identify the enhancer.

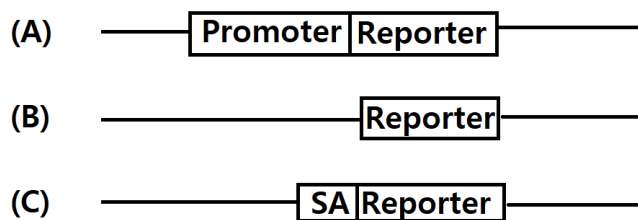

SA = Splice site Acceptor

Which of the above constructs can be used to identify the enhancer?

- (1) A only (2) B only
(3) Both A and C (4) C only

86. In a genetic assay, randomly generated fragments of yeast DNA were cloned into a bacterial plasmid containing gene 'X' essential for yeast viability on minimal media. The recombinant plasmid was used to transform a yeast strain deficient in recombination and lacking 'X' gene. Transformants, which survive on minimal media and form colonies should essentially have:

(1) Yeast centromeric sequence which ensures integrity of the plasmid after transformation.

(2) Enhancers for the essential gene missing in the transformed strain.

(3) A sequence similar to bacterial origin of replication

(4) Yeast autonomous replicating sequence.

87. Following statements have been made about recombination in a diploid organism:

A. Recombination could be identified by genotyping parents and offsprings for a pair of loci.

B. Recombination frequency does not exceed 0.5, and therefore, 50cM would be the maximum distance between two loci.

C. Recombination is a reciprocal process. However, a non-reciprocal exchange may cause gene conversion.

D. Occasionally non-homologous recombination happens and this functions as a source of chromosomal rearrangement.

Select the combination with all correct statements.

(1) A, B, C (2) A, B, D

(3) B, C, D (4) A, C, D

88. Bacteria adopt different strategies to evade host defense mechanisms. From the lists of various different mechanisms and bacterial strategies against host defense given below, select the option representing all correct pairing.

Host Mechanism	Defence	Bacterial strategies against host defence	
a	Phagocytosis	W	Change of bacterial surface charge, making it more positive
b	Release antibodies, like IgG	X	Capsular polysaccharides, such as that of <i>Klebsiella pneumoniae</i>
c	Antibody mediated agglutination	Y	Release of soluble proteins like protein A of <i>Staphylococcus aureus</i>
d	Anti microbial peptides	Z	Secretion of elastase to inactivate C3a and C5a

- (1) a-W; b-X; c-Y; d-Z (2) a-X; b-Y; c- Z; d-W
 (3) a-Z; b-Y; c-X; d-W (4) a-Y; b-W; c- Z; d-X

89. Bacterial chemotaxis response is mediated by histidine-kinase-associated receptors that activate a two-component signalling pathway which enables chemotaxis receptors to control the flagellar motors. When bacteria move towards attractant, they produce smooth swimming by rotating flagella counter-clockwise, whereas when bacteria move away from repellent, they produce increased tumbling by rotating flagella clockwise.

Which of the following characteristics regarding chemotaxis receptor is NOT true? .

- The receptors are dimeric transmembrane proteins that bind specific attractants and repellents on the outside of the plasma membrane.
- The cytoplasmic tail of the receptor is stably associated with a histidine kinase CheA via an adapter protein CheW.
- The receptor and its associated proteins are all clustered at one end of the cell.
- The binding of an attractant increases the activity of the receptor whereas binding of a repellent decreases the activity.

90. Following are a list of extracellular matrix proteins (Column A) along with their functional characteristics (Column B):

Column A		Column B	
A	Connexin	(i)	The chief endothelial cell proteins that are recognized by the white blood cell integrins and member of immunoglobulin (Ig) super family.
B	Plasmo-desmata	(ii)	Cell surface carbohydrate binding proteins that mediate a variety of transient cell-cell adhesion

			interactions in the bloodstream.
C	ICAM	(iii)	Four-pass transmembrane protein which is the major constituent of gap junctions in forming a continuous aqueous channel.
D	Selectin	(iv)	It is the only class of intercellular junctions in plants that directly connect the cytoplasm of adjacent cells.

Which one of the following is the correct match?

- A - i; B-iv; C-iii; D-ii
- A - ii; B-iii; C-iv; D-i
- A-iii; B-iv; C-i; D-ii
- A- iv; B-i; C-ii; D-iii

91. A western blot analysis after treating cancer cells with a prospective anti-cancer drug is shown below:

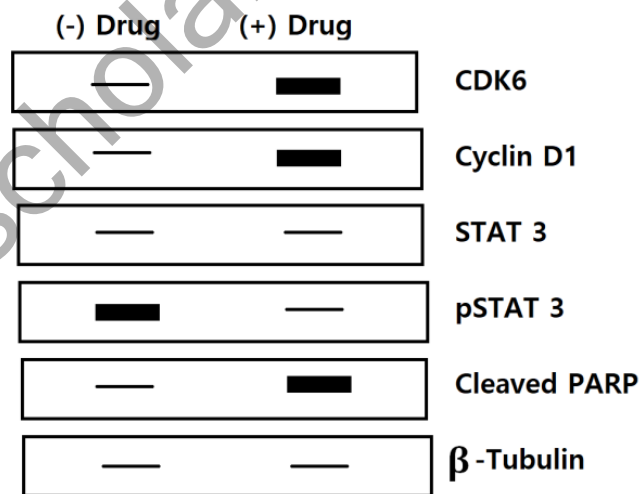

The following assumptions were made:

- The drug may have arrested the growth of cells at the G1 phase.
- The drug targeted the JAK-STAT signalling pathway.
- The drug led to apoptosis of the cells.
- Drug-induced apoptosis was through the extrinsic or mitochondrial-independent pathway.

Which one of the following combination is correct?

- Only B and D
- A, B and C
- Only A and B
- B, C and D

92. Which one of the following statements regarding clonal selection hypothesis is NOT CORRECT?

- Mature B lymphocytes bear Ig receptors on their cell surface and all receptors on a single B cell have variable specificity for antigen.
- On antigen stimulation, B cell matures, migrates to lymphoid organs and replicates. Its clonal descendents

bear the same receptor as parental B cell and secrete antibodies with identical specificity. .

(3) After immune response, more B cells bearing receptors will remain in the host and act as memory cells for mounting enhanced secondary response.

(4) B cells with receptors for self-antigens are deleted during embryonic development.

93. Susceptible individuals were infected with pathogen A and pathogen B separately. Pathogen A has a very short incubation period and disease symptoms are already underway by the time memory cells are activated. Pathogen B on the other hand has a long incubation period which allows the memory cells to be activated and respond. Which one of the following will be the most appropriate vaccination strategy against both pathogens A and B?

(1) Repeated vaccination against both A and B for maintaining high levels of neutralizing antibodies.

(2) Repeated vaccination against A and a single injection of pathogen B vaccine for maintaining high levels of neutralizing antibodies.

(3) Single injection of pathogen A vaccine and repeated vaccination against pathogen B for maintaining high levels of neutralizing antibodies.

(4) Single injection of both pathogens A and B vaccine so that memory cells can respond by producing high levels of serum antibodies.

94: Human sperms are allowed to fertilize ova having non-functional ovastacin. The following possibilities may be of significance in the fusion of these gametes:

A. The sperms will not fertilize ova.

B. The sperms will bind and penetrate the zonapellucida but will not be able to fuse with ovum membrane.

C. ZP2 will not be clipped by cortical granule protease.

D. CD9 protein of egg membrane microvilli will not be able to interact with sperm membrane proteins in the absence of ovastacin.

E. Polyspermy may occur frequently.

Which combination of statements represent the outcome of the above event?

(1) A and B (2) C and E

(3) C and D (4) B and C

95. Temporal expression of N-cadherin is extremely important during early development of the mammalian embryos. Accordingly, which one of the following statements about N-cadherin is true?

(1) Injection of N-cadherin antibodies just prior to condensation of mesenchymal cells will aid cartilage formation.

(2) Presence of N-cadherin just prior to condensation will facilitate nodule formation and development of the limb skeleton.

(3) The border between the nervous system and skin will form properly only if epidermal cells are experimentally made to express N-cadherin.

(4) Expression of N-cadherin is redundant during separation of neural and epidermal precursor cells.

96. The zygote of *C. elegans* exhibits rotational cleavage. When the first two blastomeres formed (P1 and AB) are experimentally separated, the following outcomes may be possible:

A. The P1 cell in isolation generates all the cells it would normally make, showing autonomous specification.

B. The P1 cell in isolation generates all the cells it would normally make, showing conditional specification.

C. The AB cell in isolation generates a small fraction of cell types it would normally make, showing conditional specification.

D. The AB cell in isolation generates a small fraction of cell types it would normally make, showing autonomous specification.

Which one of the above combination of statements is true?

(1) A and C (2) B and C

(3) B and D (4) A and D

97. Given below are some of the statements regarding regeneration:

A. The type of regeneration characteristic of mammalian liver is considered as compensatory regeneration.

B. Regrowth of hair shaft from follicular cells exemplifies stem cell mediated regeneration.

C. Regeneration occurring through the re-patterning of existing tissues with little new growth is known as morphallaxis.

D. Adult structures undergoing dedifferentiation forming a blastema, that then re-differentiates to form the lost structure is called epimorphosis.

Choose the most appropriate combination of correct statements:

(1) D only (2) C and D only

(3) A, B and C only (4) A, B, C and D

98. Following are certain statements regarding apomixis in plants:

- A. Apomixis cannot be used to maintain hybrid vigor over many generations in plants.
 B. In sporophytic apomixis maternal genotype is maintained.
 C. There is an event of meiosis during gametophytic apomixis and is also referred as apomeiosis.
 D. In diplospory, meiosis of the megaspore mother cell is aborted, resulting in two unreduced spores, out of which one forms the female gametophyte.

Which one of the following combinations is correct?

- (1) A and B (2) A and C
 (3) B and C (4) B and D

99. The following assumptions were derived from the above experiment:

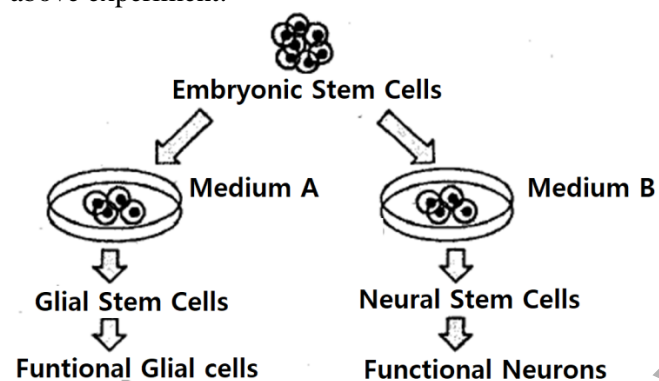

- A. Medium A contained FGF and PDGF.
 B. Medium B contained retinoic acid.
 C. Cells cultured in Medium B were determined to become functional neurons prior to addition of the medium.

Which one of the following combinations represents correct statements?

- (1) A and B only (2) A, B and C
 (3) B and C only (4) A and C only

100. Following statements were made with respect to symbiotic association of rhizobia with legumes:

- A. *nodD* is a regulatory gene.
 B. Nod factors are lipochitin oligosaccharides.
 C. Nod factors predominantly have α 1- 4 linked N-acetyl-D-glucosamine backbone.
 D. Receptors (or Nod factors are protein kinases with extracellular sugar-binding Lys M domain.

Which one of the following combinations represents all correct statements?

- (1) A, B and C (2) A, C and D
 (3) B, C and D (4) A, B and D

101. A quadratic check of gene combinations and disease reaction types in a host-pathogen system where

the gene-for-gene concept operates is represented below:

Virulence or avirulence genes in the pathogen	Resistance or susceptibility genes in the plant	
	R (resistant) dominant	r (susceptible) recessive
A (avirulent) dominant	AR	Ar
a (virulent) recessive	aR	ar

The following statements were made about the above genotypes:

- A. AR genotype had incompatible (resistant) reactions.
 B. Ar genotype had compatible (susceptible) reactions.
 C. ar genotype had compatible (susceptible) reactions.
 D. aR genotype had incompatible (resistant) reactions.
 Choose the combination with all correct statements.

- (1) A, B and D (2) A, B and C
 (3) B, C and D (4) A, C and D

102. Following observations were recorded while studying physiological parameters of sorghum and wheat under similar conditions:

- A. Sorghum RUBISCO exhibits relatively higher affinity for CO₂ compared to that of wheat.
 B. Light saturation of net photosynthetic flux is relatively lower for sorghum compared to that of wheat.
 C. Warburg effect is difficult to record for sorghum and could be said as "not measurable" whereas it could be easily recorded for wheat.
 D. Temperature optimum for net photosynthesis is lower for sorghum compared to that of wheat.
 E. 13C/12C ratio of assimilate is relatively higher for sorghum compared to that of wheat.

Which one of the following combination of the above observation is correct?

- (1) Only A, B and C (2) Only B, C and E
 (3) Only A, B and D (4) Only A, C and E

103. Following are certain statements regarding respiratory metabolism in plants:

- A. Respiratory quotient during partial breakdown of carbohydrate (alcoholic fermentation) will be infinity.
 B. Respiratory quotient indirectly provides information about (i) nature of the substrate used for respiration and (ii) the relative rate of competing respiratory processes.
 C. Breakdown of organic acids in mature fruit will exhibit a respiratory quotient value of more than one since organic acids are relatively oxygen-rich compared to other common substrates.

D. Anabolic metabolism can influence respiratory quotient by removing reduction equivalents for respiration leading to decrease in oxygen uptake.

Which one of the following combination of the above statement is correct?

- (1) Only A (2) Only B and C
(3) Only D (4) A, B, C and D

104. Sieve elements of phloem conduct sugars and other organic materials throughout the plant. The following statements were made about characteristics of sieve elements in seed plants:

- A. Angiosperms contain sieve plate pores.
B. There are no sieve plates in gymnosperms.
C. P-protein is present in all eudicots and many monocots.
D. There is no P-protein in angiosperms.

Which of the following combination is correct?

- (1) B, C and D (2) A, B and C
(3) A, B and D (4) A, C and D

105. The plant hormones, auxins and cytokinins, and their interactions play an important role in regulating apical dominance. The following figure represents an experiment related to the study of gene interactions that influence axillary bud outgrowth or dormancy. Q, Z and M represent genes involved in phytohormone pathway.

Based on the above figure, the following statements were made:

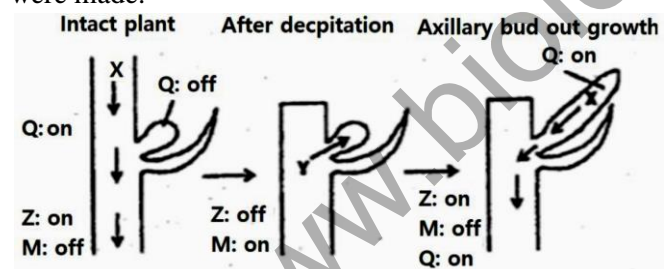

- A. 'X' is an auxin that maintains expression of 'Q' and 'Z' and represses 'M'.
B. 'Y' is a cytokinin that promotes axillary bud growth and is induced by 'M'.
C. Decapitation (removal of apex) activates
D. 'X' is a cytokinin that represses 'M'. 'X'

Which one of the following options represents correct statement(s)?

- (1) A and C only (2) B and D only
(3) A and B only (4) C only

106. The conduction velocity of action potential in a myelinated nerve fibre was much greater than that of an unmyelinated fibre of the same diameter. The

following statements were proposed to explain this observation:

- A. The speed of conduction in a nerve fibre is determined by the plasma membrane resistance and axial resistance of axonal cytoplasm.
B. The electrical properties of myelinated and unmyelinated nerve fibres are not similar.
C. The myelin sheath decreases the effective membrane resistance.
D. The magnitude of an electrotonic potential decreases more with distance along the axon in myelinated nerve fibres than that of unmyelinated fibres.
E. The voltage-gated Na⁺ channels are highly concentrated at the nodes of Ranvier.

Choose one of the following combinations with both INCORRECT statements.

- (1) A and B (2) B and C
(3) C and D (4) D and E

107. A four year old boy was brought to hospital for weak bones in spite of sufficient intake of calcium in his diet. The attending doctor examined the functioning of the following organs:

- A. Liver B. Kidney
C. Lung D. Pancreas

Which one of the following options represents a combination of probable malfunctioning organs?

- (1) A and B (2) B and C
(3) C and D (4) A and D

108. The oxygen-haemoglobin dissociation curve illustrates the relationship between pO₂ in blood and the number of O₂ molecules bound to haemoglobin. The 'S' shape of the curve has been explained in the following proposed statements:

- A. The quaternary structure of haemoglobin determines its affinity to O₂
B. In deoxyhaemoglobin, the globin units are tightly bound in a T-configuration.
C. The interactions between globin subunits are altered when O₂ binds with deoxyhaemoglobin.
D. The affinity to O₂ in T-configuration of haemoglobin is increased.
E. In the relaxed configuration of haemoglobin, the affinity to O₂ is reduced.

Choose one of the following combinations with both INCORRECT statements.

- (1) A and B (2) B and C
(3) C and D (4) D and E

109. The changes in left atrial, left ventricular and aortic pressure in a cardiac cycle are shown below in the figure

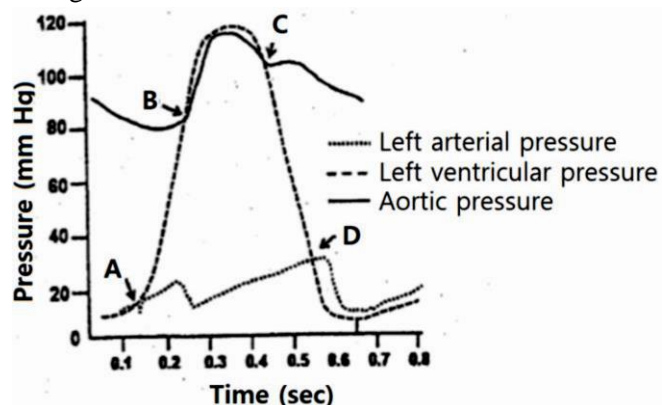

Given below are the events of cardiac cycle (column A) associated with marked points (A, B, C, D) in the figure (column B).

Column A		Column B	
a.	Aortic valve opens	(i)	D
b.	Mitral valve closes	(ii)	B
c.	Mitral valve opens	(iii)	A
d.	Aortic valve closes	(iv)	C

Choose the option that matches the events with marked points in the figure.

- (1) a - (ii), b - (iii), c - (i), d - (iv)
- (2) a - (i), b - (iv), c - (ii), d - (iii)
- (3) a - (iv), b - (i), c - (iii), d - (ii)
- (4) a - (iii), b - (ii), c - (iv), d - (i)

110. A person recovered from a moderate degree of haemorrhagic shock. The participating physiological mechanisms in this recovery process are proposed in the following statements.

- A. The decrease in arterial pressure after haemorrhage causes inhibition of sympathetic-vasoconstrictor system.
- B. After haemorrhage, the angiotensin II level in blood is increased which causes increased re-absorption of Na^+ in renal tubules.
- C. The increased secretion of vasopressin after haemorrhage increases water retention by the kidneys.
- D. After haemorrhage, the reduced secretion of epinephrine and nor-epinephrine from adrenal medulla induces decreased peripheral resistance.
- E. In haemorrhage, the central nervous system ischemic response elicits sympathetic inhibition.

Choose one of the following combinations with both the correct statements.

- (1) A and B
- (2) B and C
- (3) C and D
- (4) D and E

111. A healthy individual was immersed in water up to neck in an upright posture for 3h. The plasma concentration of atrial natriuretic peptide (ANP), renin and aldosterone were measured for 5 h at 1 h intervals including the immersion period. The results are graphically presented below.

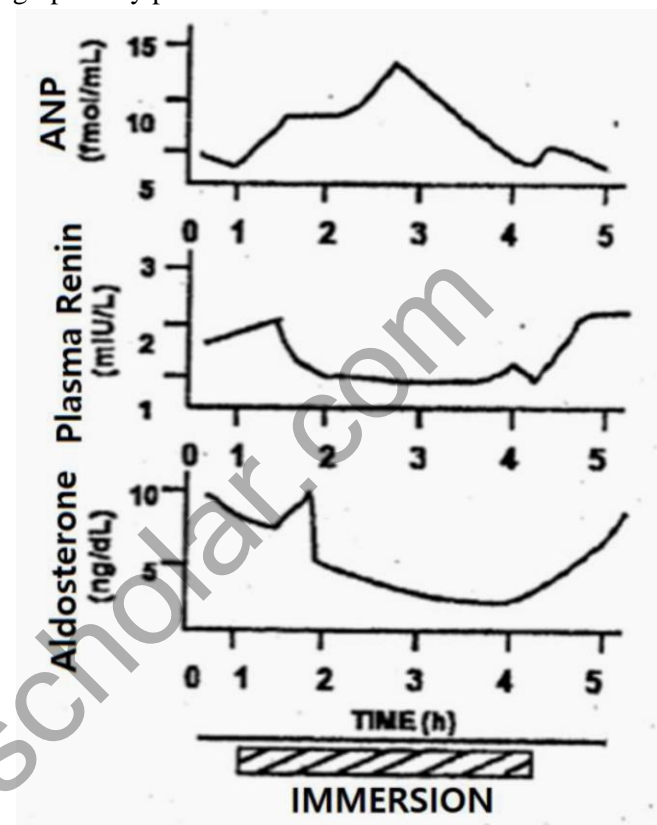

The results of this experimental condition (EC) are explained in the following proposed statements which may be correct or incorrect.

- A. ANP secretion is proportional to the degree of stretch of atria.
- B. The decreased plasma renin concentration in EC is due to increase in sympathetic activity.
- C. The decreased aldosterone level in EC is the effect of plasma renin level.
- D. The effect of gravity on the circulation is counteracted in EC.
- E. The central venous pressure is decreased in EC.

Choose one of the following combinations with all correct statements.

- (1) A,B,C
- (2) A,C,D
- (3) C,D,E
- (4) B,C,D

112. Several mutants (1-4) are isolated, all of which require compound E for growth. The compounds A to D in the biosynthetic pathway to E are known; but their order in the pathway is not known. Each compound is tested for its ability to support the growth of each mutant (1-4). In the following table, a plus sign indicates growth and a minus sign indicates no growth.

Mutants	Medium supplemented with compound				
	A	B	C	D	E
1	-	-	-	+	+
2	-	+	+	+	+
3	-	-	+	+	+
4	-	-	-	-	+

What is the order of the compounds (A to E) in the pathway?

- (1) E → D → C → B → A
- (2) A → C → D → B → E
- (3) E → B → D → C → A
- (4) A → B → C → D → E

113. Following is the picture of an inversion heterozygote undergoing a single crossing-over event

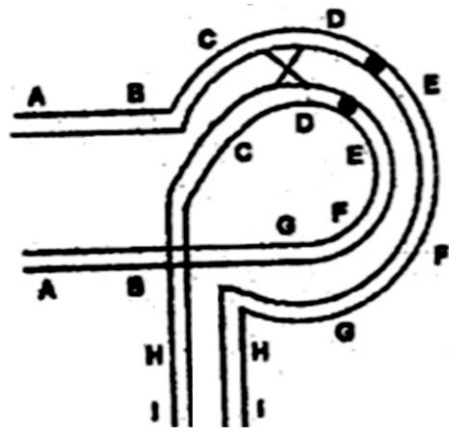

The following statements are given towards explaining the consequences at the end of meiosis.

- A. The resultant two chromosomes will have deletions and duplications.
- B. A dicentric and an acentric chromosome will be formed.
- C. The inversion does not allow crossing over to occur, so even if a crossing over is initiated, it will fail to occur.
- D. The crossing over is considered suppressed by inversion as the acentric chromosome will not segregate normally.
- E. All the gametes formed with cross-over chromatids at the end of meiosis will be non-viable as they carry large deletion or duplication.
- F. The gametes having non-crossover (parental) chromatid will survive.

Which combination of statements is correct?

- (1) B and E
- (2) A and C
- (3) B, D and F
- (4) A, E and F

114. Polymorphic DNA sequences are used for molecular identification. Short tandem repeats (STRs) and Single Nucleotide Polymorphism (SNPs) are used as polymorphic markers.

The table below summarizes the status of autosomal SNP, autosomal STR, mitochondrial SNP, Y-linked STR for four individuals related to each other, representing parents and their two children.

Indivi dual	Autosomal		Mt DNA		Y-linked
	SNP	STR	SNP1	SNP2	STR
A	C/C	13/12	C	G	13
B	C/G	13/13	C	A	13
C	C/G	14/13	C	A	-
D	C/C	13/14	C	A	-

Based on the above data, identify the individuals representing the two parents.

- (1) Individuals A and D
- (2) Individuals A and C
- (3) Individuals B and C
- (4) Individuals C and D

115. An autosomal recessive condition affects 1 newborn in 10,000 in a random mating population without any disruptive acting force. What is the approximate expected frequency of carriers in this population?

- (1) 1 in 1000 newborns
- (2) 1 in 500 newborns
- (3) 1 in 100 newborns
- (4) 1 in 50 newborns

116. Angelman syndrome (AS) and Prader-Willi Syndrome (PWS) have very distinct symptoms.

Factors responsible for the occurrence of these syndromes are given below:

- A. Microdeletion of 15q 11-13 in paternal chromosome.
- B. Uniparental disomy of maternal chromosome 15.
- C. Lack of functional maternal copy of , ubiquitin ligase E3A.
- D. Lack of SNURF-SI'-t'RPN transcript, which is produced only from paternal chromosome.
- E. Deficiencies of small nucleolar RNAs, which are encoded from the introns of SNURF'-SNRPN transcript from paternal chromosome.

Which of the following combination of answers is correct for Angelman and Prader-Willi Syndromes

- (1) Pws - A, c, D; AS - B, E
- (2) PWS -B only; AS - A, C, D E
- (3) PWS - A, B, D, E; AS – C only
- (4) PWS-A, B; AS-C,D,E

117. Using interrupted mating, four Hfr strains were analysed for the sequence in which they transmitted a number of different genes to a F- strain. Each Hfr strain was found to transmit its genes in a unique order

as summarized in the table [Only the first five genes were scored].

Order of transmission	of <i>Hfr</i> strain			
	1	2	3	4
First	A	B	M	F
	B	A	K	H
	D	L	J	G
	F	M	G	J
Last	H	K	H	K

Which one of the following correctly represents the gene sequence in the original strain from which the *Hfr* strains were derived as well as the place of integration and polarity of the F plasmid?

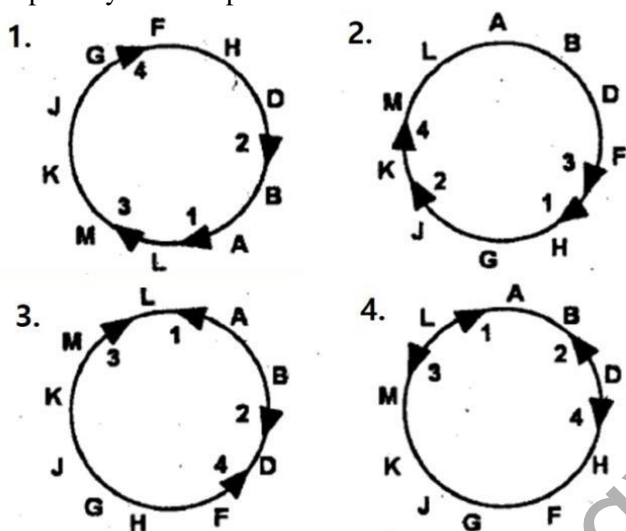

(1) Fig 1 (2) Fig 2
(3) Fig 3 (4) Fig 4

118. Given below is a list of bacteria either functioning as methanogens or methanotrophs:

- A. Methanobacterium sp
- B. Methanococcus sp
- C. Methylomonas sp
- D. Methylosinus sp

Which of the following options classifies the above list correctly?

- (1) Methanogen - A; Methanotrophs - B, C, D
- (2) Methonogens - A, B, C; Methanotroph -D
- (3) Methanogens -A, B; Methanotrophs-C, D
- (4) Methonogens - A, D; Methanotrophs -B, C

119. The table given below provides a list of groups of Arthropods (A-D) and some features (I -V):

A.	Onychophorans	(i)	Includes insects
B.	Trilobites	(ii)	Have cephalothorax and often pincer like appendage
C.	Hexapods	(iii)	Marine arthropods that disappeared in the Permian extinction
D.	Chelicerates	(iv)	Are considered related to arthropods but have unjoined appendages
		(v)	Only arthropod group without antennae

Which one of the following options represents the correct match between the arthropod groups with these features?

- (1) A - (iv) ; B - (iii) ; C - (i) ; D - (v)
- (2) A - (i) ; B - (iii) ; C - (iv) ; D - (ii)
- (3) A- (iii) ; B - (iv) ; C - (ii) ; D - (i)
- (4) A - (iv) ; B - (iii) ; C - (v) ; D - (ii)

120. In the following table, a list of threat categories and animals of India is given in an alphabetical order:

	Animal	Threat category	
i.	Bengal florican	A	Critically endangered
ii.	Ganga river Dolphin	B.	Endangered
iii.	Indian Rhinoceros	C.	vulnerable
iv.	Indian Vulture		

Which of the following options show correct combination of animals and their threat category as per Red Data list of IUCN?

- (1) i - A ; ii - A ; iii - B; iv- C
- (2) i-A; ii-B; iii-C; iv-A
- (3) i-B; ii-C; iii-B; iv-A
- (4) i-C; ii-A; iii-a; iv-B

121. Following table shows presence (+) and absence (-) of selected distinguishing characters of different plant taxa:

TAXON	Characters			
	Xylem and Phloem	Woods	Flowers	Seeds
A	+	-	-	-
B	+	+	+	+
C	-	-	-	-
D	+	+	-	+

Based on the above, which of the following shows correct identity of taxa A, B, C and O?

- (1) A - Homworts; B - Oaks; C - Ferns; D-Pines
- (2) A - Ferns; B - Oaks; C - Hornworts; D-Pines
- (3) A - Homworts; B - Pines; C - Ferns; D-Oaks
- (4) A - Ferns; B - Pines; C - Hornworts; D-Oaks

122. Following table shows an alphabetical list of certain domesticated crops and places of origin:

Crop		Place of origin	
i	Barley	A	China
ii	Maize	B	Fertile crescent
iii	Mung Bean	C	India
iv	Rice	D	Southern maxico
v	Wheat		

Based Number of grass species on the above, which one of the following options represent the correct match between crops and their place of origin?

- (1) i-C; ii-D; iii-A; iv-B; v-B
- (2) i-B; D; ii-B; iii-A, C; iv-A; v-B
- (3) i-C; ii-D; iii-C; iv-B; v-C
- (4) i - B; ii- D; iii - C; iv -A, C; v -B

123. A list of floral formulae and plant families are given in the following table:

FLORAL FORMULA	FAMILY
i. $\oplus \text{ } \ominus \text{ } \text{K}(5) \text{C}(5) \text{A}(5) \underline{\text{G}}(2)$	A. Brassicaceae
ii. $\oplus \text{ } \ominus \text{ } \text{P}(3+3) \text{A}(3+3) \underline{\text{G}}(3)$	B. Fabaceae
iii. $\oplus \text{ } \ominus \text{ } \text{K}2+2 \text{C}4 \text{A}2+4 \underline{\text{G}}(2)$	C. Liliaceae
iv. $\dagger \text{ } \text{K}(5) \text{C}(2),3 \text{A}10 \underline{\text{G}}1$	D. Solanaceae

Which of the following options most appropriately matches given plant families with their representative floral formulae?

- (1) i-D; ii-B; iii-A; iv-C
- (2) i - D; ii - C; iii - A; iv - B
- (3) i - D; ii - C; iii - B; iv - A
- (4) i-A; ii-C; iii-B; iv-D

124. Grassland plots with varying number of grass species were cultivated for 10 years. At the end of the experiment, total plant cover was measured. Soil nitrogen was also measured to assess its utilization by plants. The relationships are shown in the following plots.

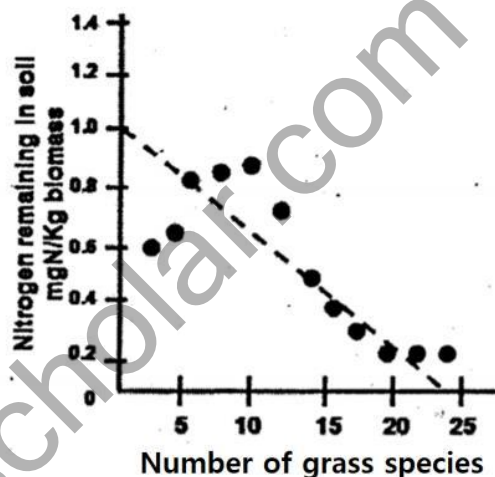
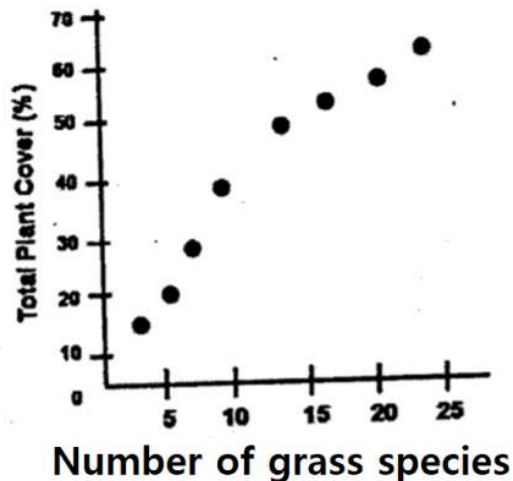

Which one of the following inferences can be drawn from the above experiment?

- (1) Grasses in plots with lower species richness enriched soil nitrogen, thereby increasing the plant cover.
- (2) Plots with greater species richness showed greater stability and more efficient soil nitrogen utilization.
- (3) Plots with greater species richness utilized nitrogen more efficiently, but would not show increased net primary production.
- (4) No correlation can be drawn between species richness, community productivity and nitrogen utilization.

125. Complete the following sentence with the most appropriate option.

Global analysis of a large number of plant species traits showed that with increase in leaf lifespan,

- (1) specific leaf area increases whereas leaf nitrogen and net photosynthesis rate decrease.
- (2) specific leaf area, leaf nitrogen and net photosynthesis rate increase.
- (3) specific leaf area, leaf nitrogen and net photosynthesis rate decrease.
- (4) specific leaf area decreases whereas leaf nitrogen and net photosynthesis rate increase.

126. Forest fragments in an agricultural landscape can be viewed as islands of habitat in an ocean of non-habitat.

MacArthur and Wilson's island biogeography model can be used to predict patterns of species richness in these forest fragments which are represented in the graphs below.

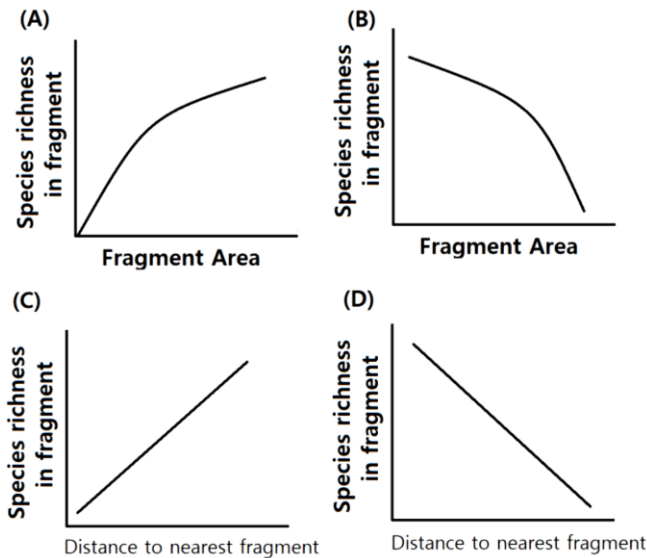

Which one of the following combinations of the graphs correctly represents predictions from the model?

- (1) A and C
- (2) A and D
- (3) B and C
- (4) B and D

127. In order to estimate population size of a fish species in a lake, a researcher captures 100 fish from the lake and marks them with coloured tags a week later, the researcher return to the lake and catches 150 fish of the and finds that 25 of them are tagged ones. Assuming no immigration or emigration occurred, the total population size of the fish species in the lake will be:

- (1) 17
- (2) 38
- (3) 600
- (4) 86

128. Given below is a graphical representation of plant life histories based on Grime's model in which disturbance and competition are the important factors.

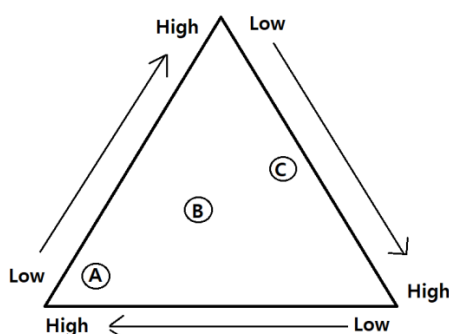

Which of the following options correctly represents A, B and C, respectively in the figure above?

- (1) perennial herbs, trees and shrubs, annual plants.
- (2) annual plants, perennial herbs, trees and shrubs.
- (3) annual plants, trees and shrubs, perennial herbs.
- (4) trees and shrubs, perennial herbs, annual plants.

129. Following table shows attributes of selected species A, B, C and D:

Attributes	Species			
	A	B	C	D
Dispersal ability	High	Low	High	Low
r Selected	Yes	Yes	No	No
Predominant reproduction mode	Asexual	Sexual	Asexual	Sexual
Competitive ability	High	Low	High	Low

Based on the above information, which of the following is most likely to become invasive if climate matches between its site of origin and site of colonization?

- (1) Species A and D
- (2) Species A only
- (3) Species D only
- (4) Species B and C

130. Four drugs (A,B,C,D) were used to disrupt a biological rhythm in experimental animals. The changes in the pattern of the biological rhythm as compared to untreated are shown below. The solid line represents the biological rhythm of the untreated and broken line represents that of the treated animals.

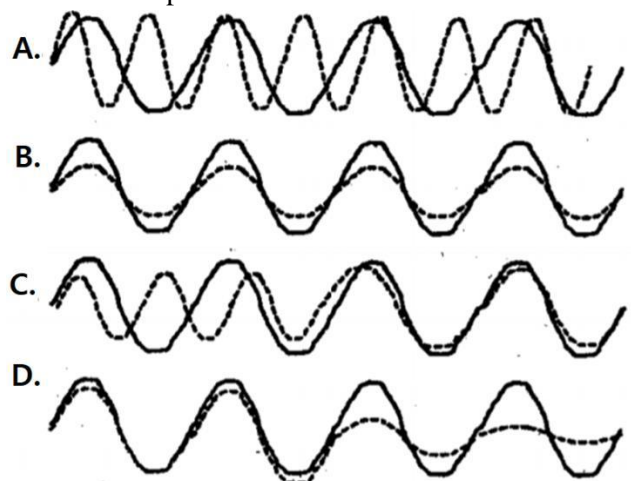

Which of the following interpretations from the above experiment is INCORRECT?

- (1) Drug A can be used to reduce the period length of the rhythm.
- (2) Drug B can be used for sustained lowering of amplitude of the rhythm without changing its period.
- (3) Drug C can be used for sustained lowering of amplitude and period of the rhythm.

(4) Drug D can be used to reduce the robustness and dampen out the rhythm.

131. The phylogenetic tree below shows evolutionary relationships among 8 species.

Males of these species are either blue (b) or red (r) in colour, the colour being indicated next to each species name.

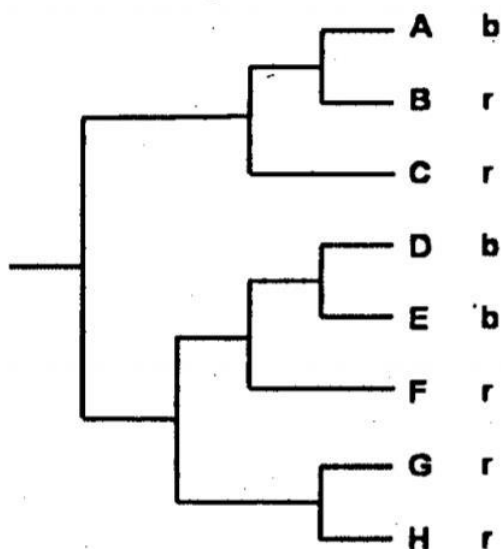

Based on the principle of parsimony, which of the following statements best represents, the evolution of male body colour in this set of species?

- (1) The most recent common ancestor of all 8 species was blue; red evolved independently 5 times.
- (2) The most recent common ancestor of all 8 species was blue; red evolved independently 4 times.
- (3) The most recent common ancestor of all 8 species was red; blue evolved independently 3 times.
- (4) The most recent common ancestor of all 8 species was red; blue evolved independently 2 times.

132. An alphabetical list of tropical rainforest mammals from South America and Africa is given below:

South America		Africa	
i	Agouti	A	Bosman's Potto
ii	Giant Armadillo	B	Chevrotain
iii	Paca	C	Pangolin
iv	Three toed sloth	D	Royal Antelope

Pair the species in the list to demonstrate the concept of convergent evolution between the two continents.

- (1) i- D; ii- C; iii - A; iv-B
- (2) i - A; ii - C; iii - D; iv - B
- (3) i - A; ii - B; iii- D; iv: C
- (4) i - D; ii - C; iii - B; iv - A

133. A study tested the importance of learning mechanisms in the development of antipredator escape responses in tadpoles of a frog species. Tadpoles hatched from eggs in the lab were kept individually either with predator chemical cues (PRIOR EXPOSURE) or without predator chemical cues (NAIVE) for 1 week.

These individuals were tested for their escape response when exposed to a live predator. They were tested either alone or together with 3 older experienced tadpoles. The graph below shows the escape response of the test individuals in the four different treatments.

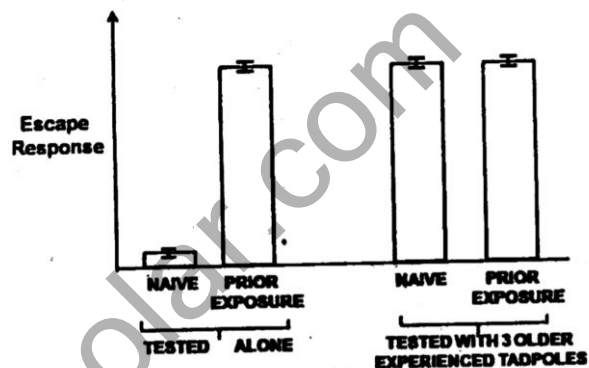

Some of the inferences drawn are given below:

- Prior exposure to predator cues is necessary for the development of escape response.
- Prior exposure to predator cues positively influences the development of escape response.
- The presence of older experienced individuals is necessary for the development of escape response.
- The presence of older experienced individuals positively influences the development of escape response.
- An individual with prior exposure and with older and experienced individuals showed the strongest escape response.

Which one of the following combination of statements represents the correct inference from the experiment?

- (1) A and C
- (2) B and D
- (3) A and D
- (4) A, C and E

134. Beak shape in birds has evolved in response to their diet.

The table listing bird species and food type is given below:

Bird species	Food type
i	Barn swallow A Fruits
ii	Great hornbill B Insects
iii	House sparrow C Nectar
iv	Purple sunbird D Seeds

Match the bird species shown above to their main food resource.

- (1) i-D; ii-A; iii-C; iv-B
- (2) i-B; ii-D; iii-A; iv-C

(3) i-C; ii-B; iii-D; iv-A (4) i-B; -ii-A; iii-D; iv-C

135. Given below are four statements related to Agrobacterium-mediated transfer of T-DNA into plant cells:

- A. Production of single-stranded T-DNA by VirD1 and VirD2 proteins.
- B. Interaction of VirE2 with VIP1 and VirE(3)
- C. Use of VirB/VirD4 type IV secretion system.
- D. Activation of VirA-VirG complex.

The correct sequence of events (from earliest to latest) is:

- (1) A-B-D-C (2) B-C-A-D
- (3) C-A-B-D (4) D-A-C-B

136. Construction of knockout mice may be performed using the Cre-LoxP system. Eventually, the Cre recombinase of the bacteriophage P1 mediates site-specific recombination at a 34 bp sequence, lox P. From the following statements, choose the INCORRECT event:

- (1) The alteration of the chromosomal copy of the target gene requires a guide RNA.
- (2) The loxP containing mice should not express Cre recombinase prior to mating.
- (3) The Cre recombinase can be expressed by an inducible promoter.
- (4) Induction of the promoter results in the expression of Cre, recombination at lox P sites and excision of the sequence in between.

137. Monoclonal antibodies can be modified for better research and therapeutic applications.

Several such approaches are mentioned below (Column A) along with their possible applications (Column B).

Column A		Column B	
i.	Binding site of the original mouse mAb are placed onto the Fe regions of human antibodies	a	Abzymes
ii.	Antibodies are modified by conjugation to toxins designed to kill cells to which the antibody will bind	b	Reduce side effect of xenogenic antibodies in immunotherapy
iii.	Generation of mAb that	c	Immunotoxins

	specifically bind and stabilize the transition state of a chemical reaction		
--	---	--	--

Which one of the following options represents a correct combination of terms in Column A and Column B?

- (1) i-a; ii-b; iii-c (2) i-b; ii-a; iii-c
- (3) i-c; ii-b; iii-a (4) i-b; ii-c; iii-a

138. Given below is a table comprising various terms associated with plant tissue culture in Column A and Column B.

Column A		Column B	
A	Auxin	i	Embryogenesis
B	Protoplast culture	ii	6-Furfuryl amino purine
C	Cytokinin	iii	Pectinase and Cellulase
D	Microspore culture	iv	Indole-3-acetic acid

Which one of the following options represents the most appropriate match between all the terms of Column A and Column B?

- (1) A-ii; B-i; C-iv; D-iii (2) A-iv; B-iii; C-ii; D-i
- (3) A-ii; B-iv; C-i; D-iii (4) A-iv; B-i; C-ii; D-iii

139. In an attempt to increase the yield of a commercially important enzyme from natural isolate several strategies were adopted as follows:

- A. Genome was selectively modified to increase yield.
- B. Reappraisal of culture requirements of the modified organism to increase yield.
- C. Induced mutants were screened and selected for organism synthesizing improved levels of the enzyme.
- D. Organism was genetically modified, so that it produces a factor that enhances stability of the enzyme.

Which one of the following options represents strategies that are appropriate for the purpose?

- (1) A, B, C and D (2) B and C only
- (3) A, C and D only (4) A and B only

140. Given below are names of techniques (Column A) and their characteristic features/applications (Column B):

Column A		Column B	
A.	Hybridoma technology	(i)	Separation of technology proteins according to charge

B.	MALDI-TOF	(ii)	Identification of protein complexes in cells
C.	Ion-exchange chromatography	(iii)	Production of identical antibodies
D.	Co-immunoprecipitation	(iv)	Determination of molecular weight of proteins and/or peptides

Which one of the following represents a correct match between Column A and Column B:

- (1) A-(ii); B-(iii); C-(iv); D-(i)
- (2) A-(iii); B-(iv); C-(i); D-(ii)
- (3) A-(iv); B-(i); C-(ii); D-(iii)
- (4) A-(ii); B-(iv); C-(i); D-(iii)

141. Three proteins *Blm 1*, *Blm 2*, *Blm 3* were shown to be involved in repair of DNA double strand breaks. A chromatin immunoprecipitation experiment was performed for the three proteins.

The pattern of results obtained is shown below:

	0 Min (before break)			30 min (after break)		
	INPUT	0 Kb from break	1 Kb from break	INPUT	0 Kb from break	1 Kb from break
		—	—		—	—
<i>Blm 1</i>	—	—	—	—	—	—
<i>Blm 2</i>	—	—	—	—	—	—
<i>Blm 3</i>	—	—	—	—	—	—

Based on the above figure, choose the option that correctly interprets the data.

- (1) *Blm 1*, *Blm 2*, *Blm 3* bind to DNA break sites
- (2) *Blm 1* binds to the break site; *Blm 3* binds to the break site and beyond
- (3) *Blm 2* remains bound to DNA after the break is induced
- (4) *Blm 3* binds to DNA irrespective of the break

142. The most important property of any microscope is its resolution (D).

Which one of the following wavelengths (nm) would be used to achieve the best resolution using a light microscope with lenses having numerical aperture (NA) of 1.4?

- (1) 450
- (2) 480
- (3) 560
- (4) 700

143. Detailed NMR spectra of a 20-residue peptide were recorded using a 600 MHz instrument.

If the peptide adopts an α helical conformation, which one of the following statements is correct?

- (1) Prominent $NH_i - NH_{i+1}$ NOE peaks would be observed along with $^3J_{NH} - HA$ coupling constants 8.5 Hz

(2) Prominent $C\alpha H_i - NH_{i+1}$ NOE peaks would be observed along with $^3J_{NH} - HA$ coupling constants 4.8 Hz

(3) Prominent $C\alpha H_i - NH_{i+1}$ NOE peaks with $^3J_{NH} - HA$ coupling constants 8.5 Hz

(4) Prominent $NH_i - NH_{i+1}$ NOE peaks along with $^3J_{NH} - HA$ coupling constants 4.8 Hz

144. Given below are names of statistical distribution (Column I) and their characteristic features (Column II)

Column I		Column II	
A	Binomial distribution	i	Each observation represents one of two outcomes (success or failure)
B	Poisson distribution	ii	Probability that is symmetric about the mean
C	Normal distribution	iii	Probability of a given number of events happening in a fixed interval of time

Which one of the following represents a correct match between columns I and II?

- (1) A-(ii); B-(i); C-(iii)
- (2) A-(i); B-(ii); C-(iii)
- (3) A-(i); B-(iii); C-(ii)
- (4) A-(iii); B-(ii); C-(i)

145. Highly purified peptides P1, P2 and P3 were subjected to MALDI mass spectral analysis. The following observations were made:

P1: Showed a m/z of 16 more than the expected value.

P2: Showed a m/z of 80 more than the expected value. MS/MS spectra of the peptide resulted in a precursor ion with m/z 98 less than the expected m/z .

P3: Showed a m/z that was double the expected value. [Note: $z = +1$ for all the mass spectra.]

Which one of the options given below comprises all correct interpretations?

- (1) P1: Cys is oxidized; P2: has undergone oxidation at multiple Met residues; P3: is a non-covalent dimer.
- (2) P1: Met is oxidized; P2: is phosphorylated; P3: is a covalent dimer.
- (3) P1: Met is oxidized; P2: multiple Cys are oxidized; P3 is a covalent dimer.
- (4) P1: Cys is oxidized; P2: phosphorylated and oxidized at Met; P3: is a noncovalent dimer.